

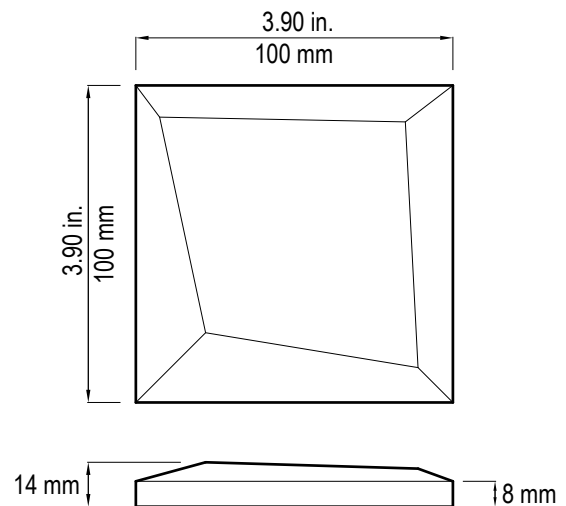

LUNADA  
BAYTILE

## Origami Field Trapeze (4 x 4)

- Not suitable for submerged water applications
- Size Nominal

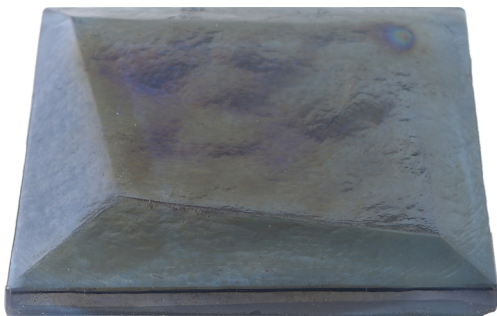
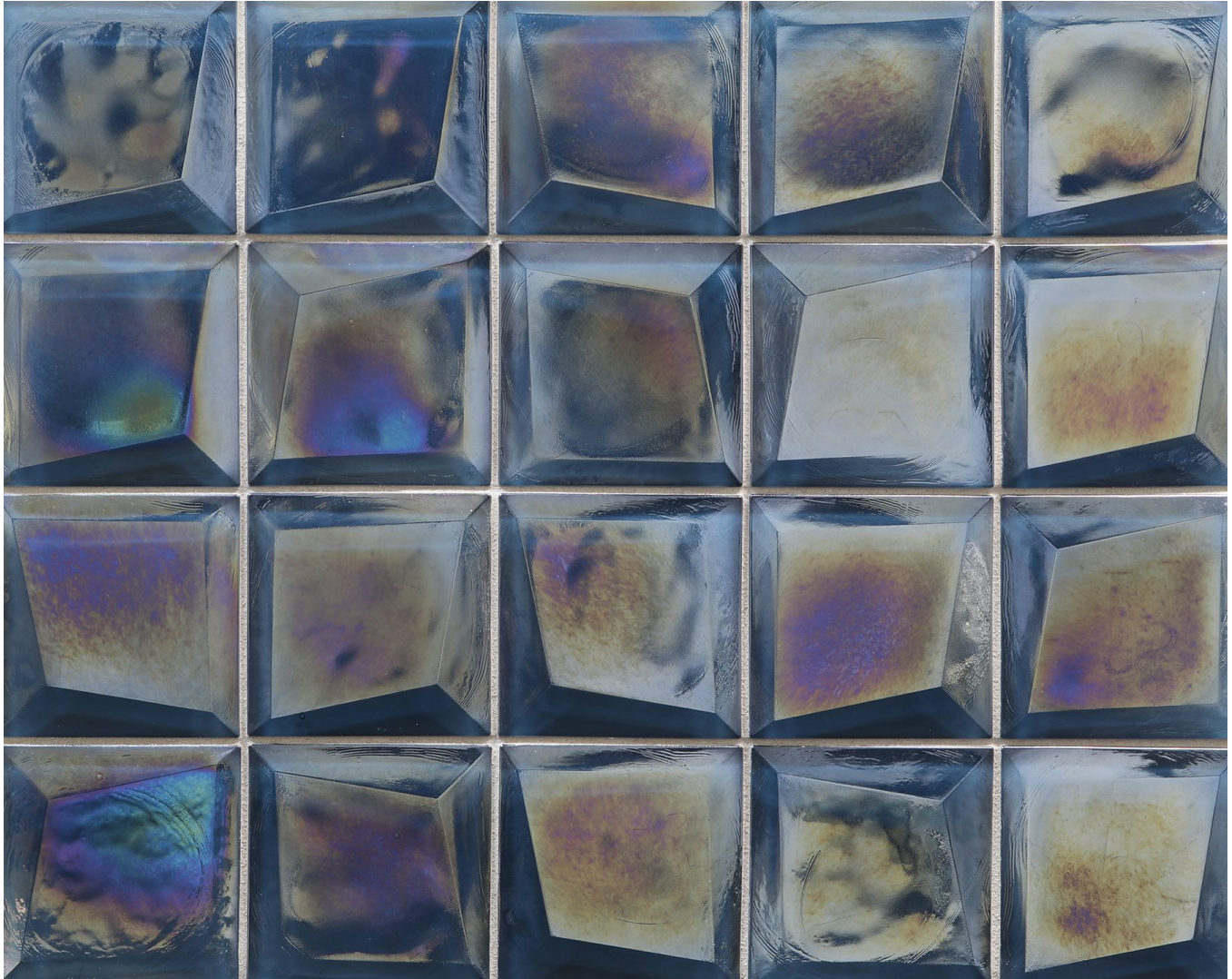

Trapeze (4 x 4)  
(Color shown Cottage Blue)





LUNADA  
BAYTILE

# Origami Field Trapeze (4 x 4)

- Not suitable for submerged water applications
- Size Nominal

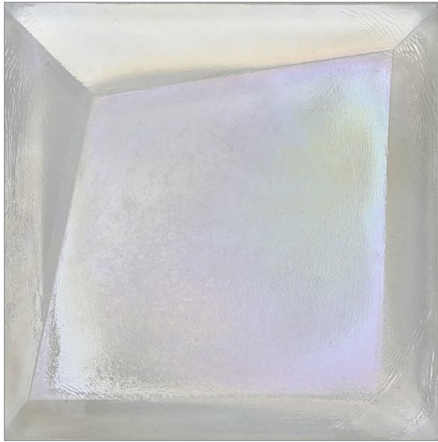

Crystal



Clear

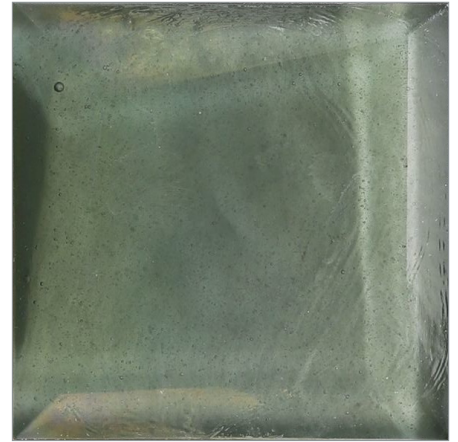

Silver

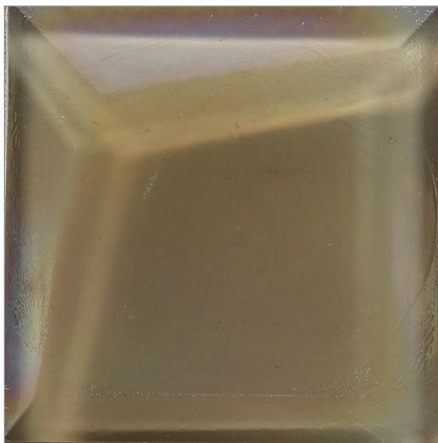

Latte



Aqua Blue

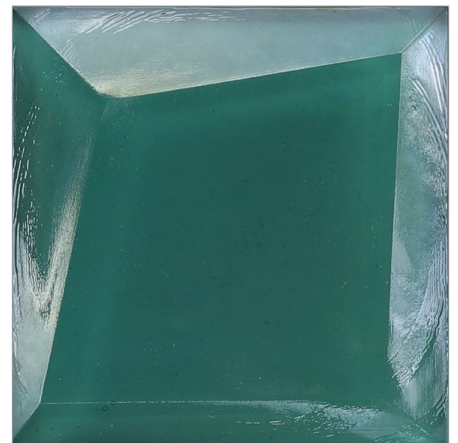

Java Blue

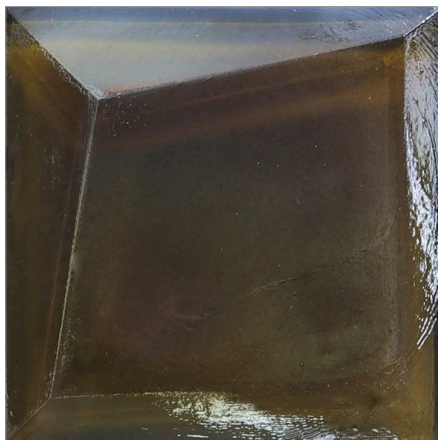

Banacha

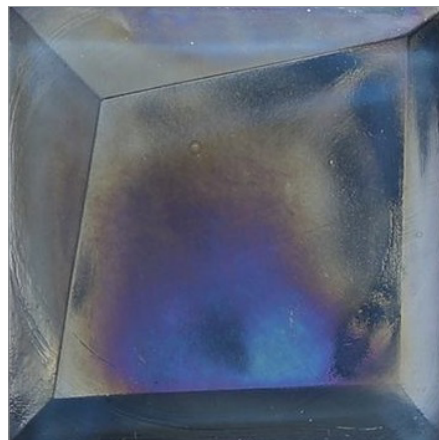

Cottage Blue



Midnight Black